

PRESSURE MASTER™ HEADER SEALS

SEALING SYSTEMS

PRESSURE MASTER™ SEALS, designed and manufactured for Earl's by Parker Hannifin Corporation, were the first high performance seals developed to solve automotive sealing problems using Aerospace Technology.

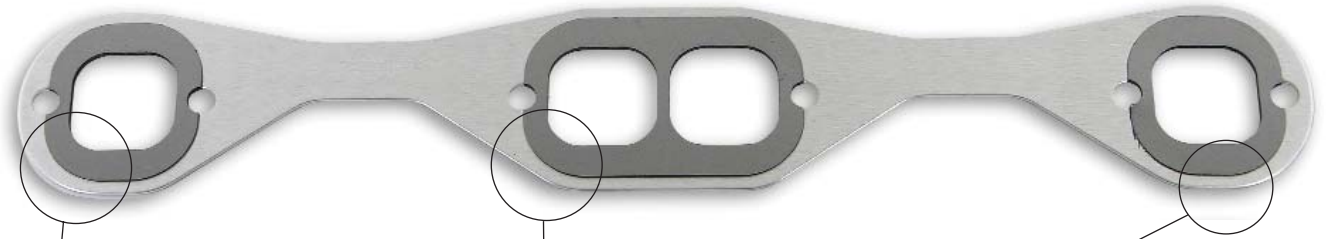

REUSABILITY/ADAPTABILITY











The graphite foil sealing inserts are replaceable in the aluminum retainer, making it an economical solution to tough sealing problems.









VIRTUALLY LEAKPROOF

Leak down tests show Earl's Pressure Master™ seals up to 1200% better under pressure than leading gasket systems.

SUPERIOR TORQUE RETENTION

TORQUE TESTS show the fastener pre-load is longer lasting. Earl's 90% break loose torque compares to 65% for our nearest competition.

PART NO.	DESCRIPTION
 CHEVY SMALL BLOCK 265-400 29D03BERL	Header Seals with 1.50" x 1.50" ports (pair)
 29D03B1ERL	replacement insert set (1.50" x 1.50" ports)
 29DA3BERL	Header Seals with D-Port LT-1 ports (pair)
 29D03B3ERL	replacement insert set (D-Port LT-1 ports)
 29DB3BERL	Header Seals with 1.36" x 1.36" ports (pair)
 29D03B4ERL	replacement insert set (1.36" x 1.36" ports)
 29DC3BERL	Header Seals with Round 1.59" Dia. ports (pair)
 29D03B5ERL	replacement insert set (Round 1.59" Dia. ports)
 29DD3BERL	Header Seals with D-Port 1.55" x 1.63" ports (pair)
 29D03B6ERL	replacement insert set (D-Port 1.55" x 1.63" ports)
 29DE3BERL	Header Seals with uncut centers (pair)
 29D03B2ERL	replacement insert set (uncut centers)

PART NO.	DESCRIPTION
 CHEVY BIG BLOCK 396-502 29D04BERL	Header Seals for Chevy with 1.50" x 1.50" ports (pair)
 29D04B1ERL	replacement insert set (1.50" x 1.50" ports)
 29D04B2ERL	replacement insert set (uncut centers)
 FORD SMALL BLOCK 289-302-351W 29D03AERL	Header Seals for Ford 289-302-351W (pair) (Except Boss)
 29D03A1ERL	replacement insert set (standard)
 29D03A2ERL	replacement insert set (uncut centers)
 FORD BIG BLOCK 429-460 29D04AERL	Header Seals for Ford 429-460 (pair)
 29D04A1ERL	replacement insert set (standard)
 29D04A2ERL	replacement insert set (uncut centers)

PRESSURE MASTER™ COLLECTOR SEALS

SEALING SYSTEMS

EARL'S PRESSURE MASTER™ COLLECTOR SEALS have all of the superior features as our header seals to solve your exhaust sealing problems.

COLLECTOR SEALS



29D15ZERL

3 Bolt 2-1/2" Dia. (pair)



29D10ZERL

3 Bolt 3" Dia. (pair)



29D20ZERL

3 Bolt 3-1/2" Dia. (pair)

REPLACEMENT INSERTS



29D15Z1ERL

3 Bolt 2-1/2" Dia. (pair)



29D10Z1ERL

3 Bolt 3" Dia. (pair)



29D20Z1ERL

3 Bolt 3-1/2" Dia. (pair)

SEALING SYSTEMS

EARL'S PRESSURE MASTER™ VALVE COVER SEALS were developed for high performance and racing engines. The sealing material is designed for long life by use of high temperature resistant silicone elastomer.

SEALABILITY

Pressure Master™ Seals provide complete and reliable sealing without the use of adhesives.

INSTALLATION

The integral seal design and metal backbone gives it the rigidity to maintain its shape.

REUSABILITY

The seals are designed for extended life by establishing optimum squeeze on the seal element. The metal inserts around the screw holes control the amount of squeeze on the rubber, preventing over tightening of the seal.

LATEST TECHNOLOGY

Bolt load is transmitted through the metal insert at the screw holes, which assures positive closure and optimum bolt pre-load

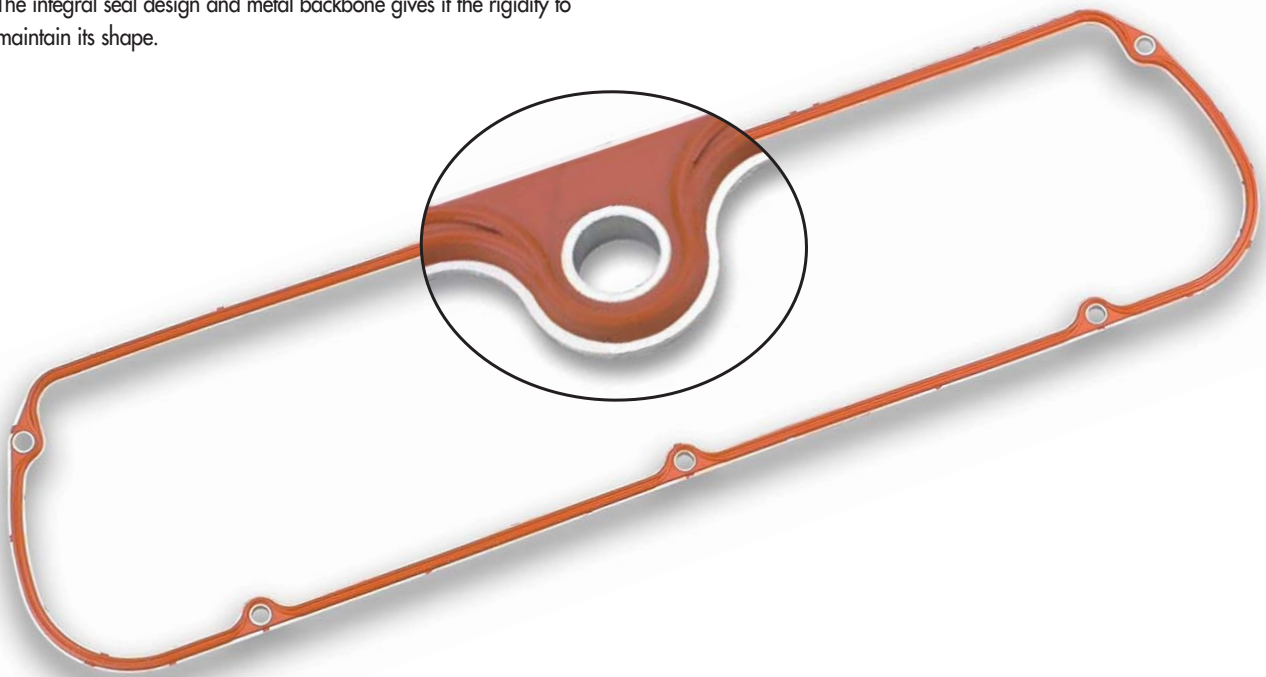

PART NO.	DESCRIPTION
----------	-------------



29E03BERL Small Block Chevy 265-400 (pair)



29E04BERL Big Block Chevy 395-502 (pair)

PART NO.	DESCRIPTION
----------	-------------



29E03AERL Small Block Ford 289-302-351W (except boss)



29E04AERL Big Block Ford 429-460 (pair)

FIREWALL GROMMET SEALS

SEALING SYSTEMS

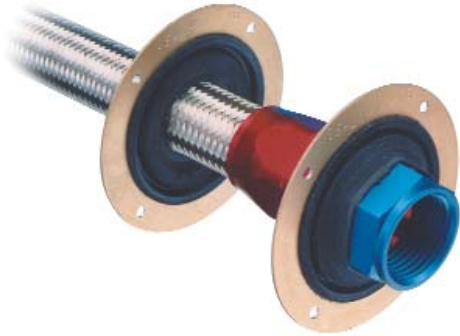

SEALS-IT has designed this unique seal that will stretch to allow the fitting to pass, yet will grip the hose, not allowing fumes or debris to pass through. Made from a fire retardant rubber bonded to an anodized aluminum bezel.

PART NO.	DESCRIPTION
----------	-------------



29G001ERL Blank seal



29G006ERL -6 hose and fitting



29G008ERL -8 hose and fitting



29G010ERL -10 hose and fitting

PART NO.	DESCRIPTION
----------	-------------



29G012ERL -12 hose and fitting

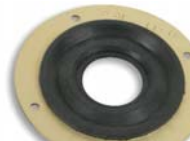

29G016ERL -16 hose and fitting



29G020ERL -20 hose and fitting

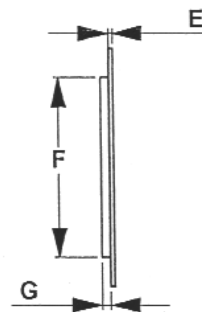
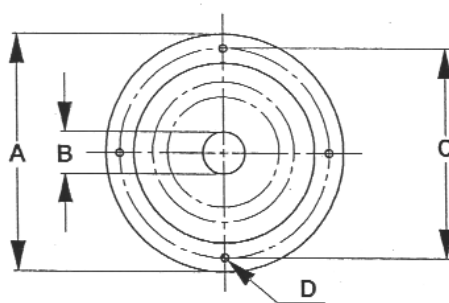

PART NO.	A	B	C	D	E	F	G
29G001ERL	3.000	NO HOLE	2.65	.125	.040	2.250	.120
29G006ERL	3.000	.375	2.65	.125	.040	2.250	.120
29G008ERL	3.000	.500	2.65	.125	.040	2.250	.120
29G010ERL	3.000	.625	2.65	.125	.040	2.250	.120
29G012ERL	3.000	.750	2.65	.125	.040	2.250	.120
29G016ERL	3.000	.950	2.65	.125	.040	2.250	.120
29G020ERL	3.000	1.180	2.65	.125	.040	2.385	.120